

# CS 600mm Teppanyaki Grills



## Technical Specifications for CS-6P-T



### PROFESSIONAL SERIES

- 16mm thick mild steel teppanyaki plate
- Chrome and ribbed plate finishes optional
- Lowered splashback to maximise cooking visibility
- Available freestanding or as a benchtop model
- Modular Professional series design
- 15 month 'Platinum Warranty'
- Easy to clean and service

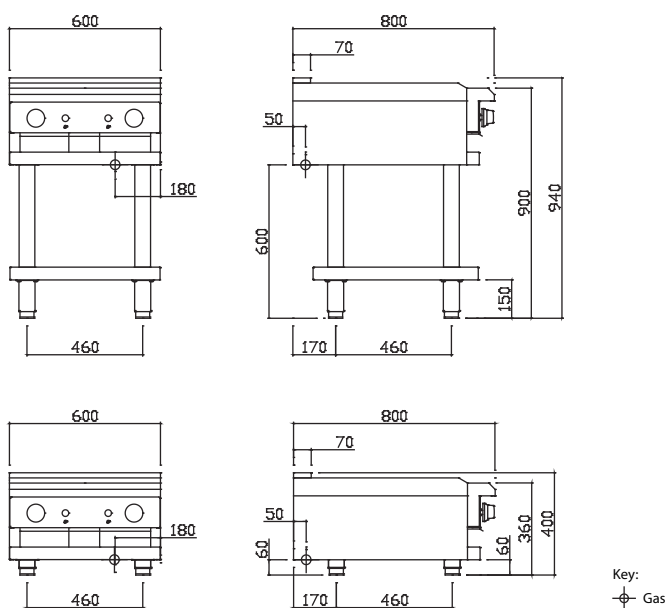

Model	Description	Nat Gas	LP Gas
CS-6P-T	600 teppanyaki grill	36 mj/h	36 mj/h

#### Teppanyaki Grill

- 18 mj/h burners with pilot, FFD and piezo ignition
- Variable flame control valve with low flame setting
- 16mm thick mild steel griddle plate
- Top weld sealed hotplate sections
- CS-6P-T plate: 590mm x 540mm; 0.32m<sup>2</sup> cooking area
- 2mm 304 stainless steel splash guards
- Griddle oil bin 1.2mm stainless steel

#### Overall Construction

- Heavy duty construction
- Low rear splashback and side skirts
- Welded 1.2mm 304 stainless steel front hob
- Front and side panels 0.9mm 304 stainless steel
- Splashback 1.2 mm 304 stainless steel
- Stainless steel legs with 55mm height adjustment range

#### Dimensions

- 600mm x 800mm x 940mm H
- 600mm x 800mm x 400mm H (benchtop)
- Working height 900mm
- Weight 77kg
- Packed dimensions 655mm x 860mm x 1120mm H
- Packed weight 97kg

#### Connections

- Gas 3/4" BSP male
- 180mm from right, 50mm from rear, 600mm from floor
- Benchtop model gas connection: 60mm from bottom
- Supplied with gas regulator (specify Nat or LP on order)

#### Cleaning & Servicing

- Easy access to all parts & components from front

#### Options/Accessories

- Rear castors
- Joining caps
- Ribbed or chrome finish on hotplates
- RH and LH side shields
- Benchtop mount (specify when ordering)
- Extended warranty

