

# CS-6C

## 600mm Gas Chargrill Cooktop



## PROFESSIONAL

### Specifications

- NAT Gas: 66 MJ/h, LP Gas: 66 MJ/h, ULP Gas: 60 MJ/h
- Supplied with Gas regulator (specify NAT or LP on order)
- Gas Inlet: 3/4" BSP Male
- 180mm from Left, 15mm from Rear, 590mm from Floor
- Benchtop model gas connection: 50mm from Floor
- Working Height: 900mm
- Dimensions: 600 x 800 x 1100H @ 98kg
- Packed Dimensions: 680 x 880 x 1245H @ 133kg
- Benchtop Dimensions: 600 x 800 x 560H @ 88kg
- Benchtop Packed Dimensions: 680 x 880 x 705H @ 118kg
- Heavy duty construction with 304 stainless steel external panels

### Chargrill

- 33 MJ/h output per 300mm module
- Stainless steel E-burners with pilot, FFD and piezo ignition
- Variable control valve with low flame setting
- Cast-iron heat distributing hood as standard
- Optional ceramic rocks for a smoky flavour
- Chargrill cooking area: 590mm x 520mm; 3068 cm<sup>2</sup>
- Heavy duty cast iron J-grate (147mm x 540mm)
- J-grates easily rotated for incline and levelled surface cooking
- 2mm 304 stainless steel splash guards

### Cleaning & Servicing

- J-grates and radiant hoods easily removable for cleaning
- Secondary undertray to catch any additional waste
- Easy access to all parts and components from front

### Options/Accessories

- Rear Castors (rigid)
- Front Castors (swivel with brakes)
- Joining caps
- J-shaped reversible grates
- LH and RH side shields
- 300mm drop on griddle plate
- Ceramic rocks (specify when ordering)
- Benchtop option (specify when ordering)

### Warranty

- 1 Year Included + 1 Year Extendable upon registration

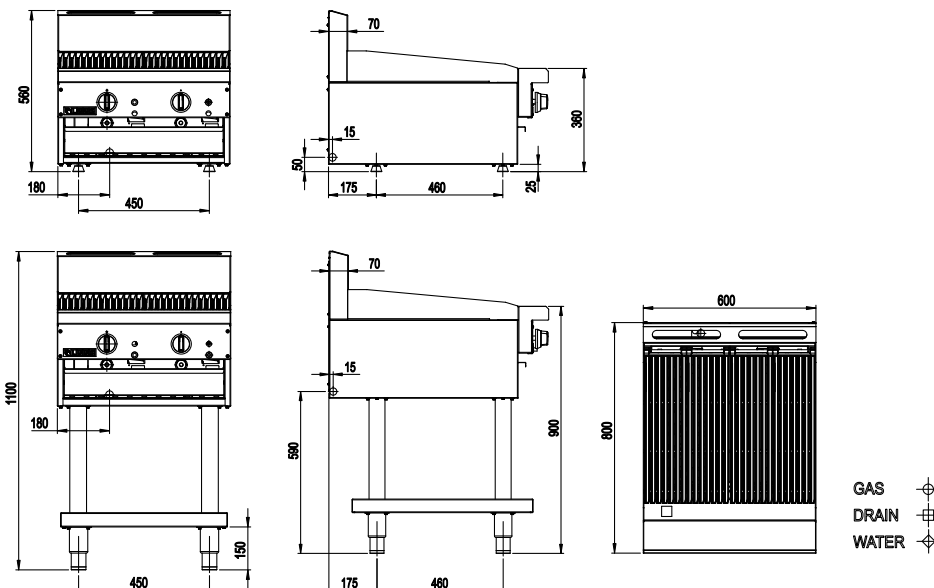

Must be installed by an authorised person in accordance with AS/NZS 3000.

Please note that specifications or design may be altered at any time without notice.

Luus Industries Pty Ltd | +61 3 9240 6822 | sales@luus.com.au | www.luus.com.au

